

# FOCUS ON

Clap by Faro Lab









## *designed by Faro Lab*

The Clap lighting collection has been conceived to take aesthetic minimalism to new horizons in the illumination of outdoor spaces and gardens. With pure design and minimal structures, this family offers both direct and indirect lighting in its various versions, transforming every corner of the outdoor spaces. Clap responds to the trend of product category hybridization, thus blurring the boundaries between indoor and outdoor luminaires. This lighting system offers great flexibility for project design thanks to its diverse categories: from stakes to beacons, pendant lights, or wall sconces, all with a distinctive and refined aesthetic. The indirect lighting of some versions provides high visual comfort and prevents glare, while eliminating light pollution and highlighting the surrounding vegetation. This collection harmoniously integrates with the environment thanks to its elegant structures, blending seamlessly with the natural landscape.

La colección de luminarias Clap ha sido concebida para llevar el minimalismo estético a nuevos horizontes en el ámbito de la iluminación de espacios al aire libre y jardines. Con un diseño puro y estructuras mínimas, esta familia ofrece una iluminación directa e indirecta en sus diferentes versiones, transformando cada rincón del entorno exterior. Clap responde a la tendencia de hibridación de categorías de productos, desdibujando así las fronteras entre luminarias de interior y de exterior. Este sistema lumínico ofrece una gran flexibilidad para el diseño de proyectos gracias a sus diversas categorías: desde estacas hasta balizas, colgantes o apliques de pared, con una estética cuidada y distintiva. La iluminación indirecta de alguna de sus versiones proporciona un alto confort visual y evita los deslumbramientos, a la vez que elimina la contaminación lumínica y resalta la vegetación circundante. Esta colección se integra armoniosamente con el entorno gracias a sus elegantes estructuras, mimetizándose con el paisaje natural.



“Its minimalist structures and pure design create elegant and serene outdoor atmospheres.”









# SURFACE



by Faro Lab

FOCUSON

## Clap projector *Proyector Clap*



75710-233

● Black

75710-133

● White

<b>Material</b>	<b>Body</b> Aluminium
<b>Power</b>	6W
<b>Lumen Output</b>	524lm
<b>Light Source</b>	COB LED 3000K
<b>Class</b>	I
<b>CRI</b>	>80
<b>Voltage (V/Hz)</b>	220V-240V/50-60Hz
<b>Beam angle</b>	38°

### Visor accessory

75714-2

● Black

**Material**

**Body** PC

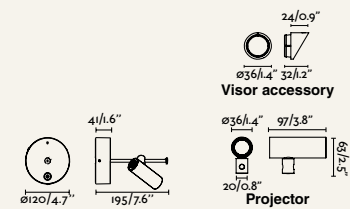





Clap projector with shade  
*Clap Proyector aplique/plafón*

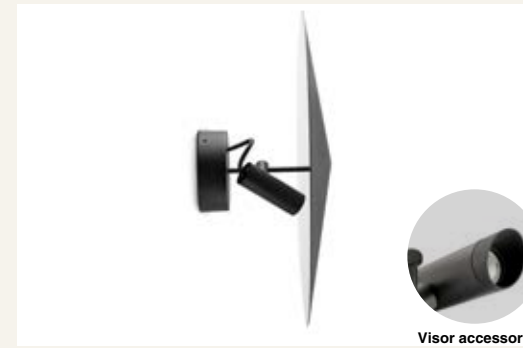

75710-233P

● Black

<b>Material</b>	<b>Body</b> Aluminium
<b>Power</b>	6W
<b>Lumen Output</b>	524lm
<b>Light Source</b>	COB LED 3000K
<b>Class</b>	I
<b>CRI</b>	>80
<b>Voltage (V/Hz)</b>	220V-240V/50-60Hz
<b>Beam angle</b>	38°

Visor accessory

75714-2

● Black

<b>Material</b>	<b>Body</b> PC
-----------------	----------------

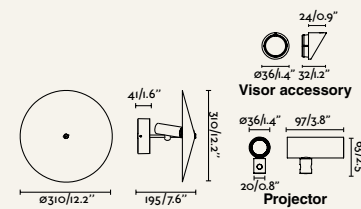



Clap surface linear  
*Superficie Clap lineal*



- 75712-233 ● Black
- 75712-133 ● White

<b>Material</b>	<b>Body</b> Aluminium
<b>Power</b>	3X6W
<b>Lumen Output</b>	3x524lm
<b>Light Source</b>	COB LED 3000K
<b>Class</b>	I
<b>CRI</b>	>80
<b>Voltage (V/Hz)</b>	220V-240V/50-60Hz
<b>Beam angle</b>	38°
<b>Cable</b>	2 MT

<b>Visor accessory</b>	
75714-2	● Black
<b>Material</b>	<b>Body</b> PC

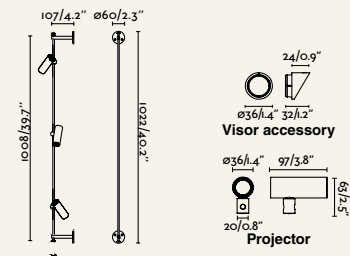









# FLOOR



Clap beacon 512  
Clap baliza 512

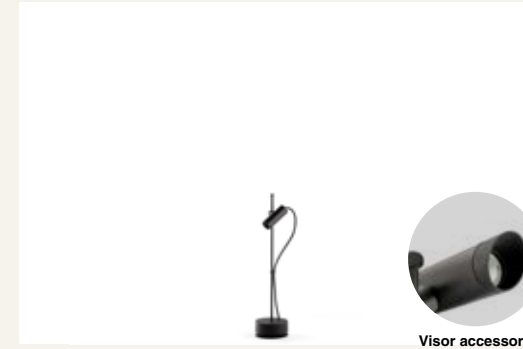

75704-233

● Black

<b>Material</b>	<b>Body</b> Aluminium
<b>Power</b>	6W
<b>Lumen Output</b>	524lm
<b>Light Source</b>	COB LED 3000K
<b>Class</b>	I
<b>CRI</b>	>80
<b>Voltage (V/Hz)</b>	220V-240V/50-60Hz
<b>Beam angle</b>	38°

Visor accessory

75714-2

● Black

**Material** **Body** PC

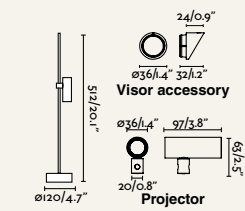

Clap beacon 1266  
Clap baliza 1266



75705-233

● Black

<b>Material</b>	<b>Body</b> Alumi.+Stainless steel
<b>Power</b>	2X6W
<b>Lumen Output</b>	2x524lm
<b>Light Source</b>	COB LED 3000K
<b>Class</b>	I
<b>CRI</b>	>80
<b>Voltage (V/Hz)</b>	220V-240V/50-60Hz
<b>Beam angle</b>	38°

Visor accessory

75714-2

● Black

**Material** **Body** PC

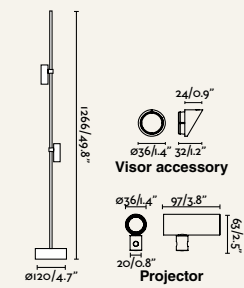





Clap beacon 512 with screen  
*Clap baliza 512 con pantalla*



75704-233P

● Black

<b>Material</b>	<b>Body</b> Aluminium
<b>Power</b>	6W
<b>Lumen Output</b>	524lm
<b>Light Source</b>	COB LED 3000K
<b>Class</b>	I
<b>CRI</b>	>80
<b>Voltage (V/Hz)</b>	220V-240V/50-60Hz
<b>Beam angle</b>	38°

Visor accessory

75714-2

● Black

**Material** **Body** PC

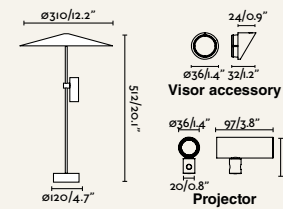

Clap beacon 1266 with screen  
*Clap baliza 1266 con pantalla*



75705-233P

● Black

<b>Material</b>	<b>Body</b> Alumi.+Stainless steel
<b>Power</b>	2X6W
<b>Lumen Output</b>	2x524lm
<b>Light Source</b>	COB LED 3000K
<b>Class</b>	I
<b>CRI</b>	>80
<b>Voltage (V/Hz)</b>	220V-240V/50-60Hz
<b>Beam angle</b>	38°

Visor accessory

75714-2

● Black

**Material** **Body** PC

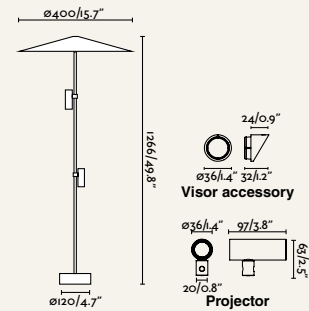









# PROJECTORS & SPIKES



Clap tree mounting projector 24V  
Clap proyector árbol 24V



75703-233

● Black

<b>Material</b>	<b>Body</b> Aluminium
<b>Power</b>	6W
<b>Lumen Output</b>	524lm
<b>Light Source</b>	COB LED 3000K
<b>Class</b>	III
<b>CRI</b>	>80
<b>Voltage (V/Hz)</b>	24V DC
<b>Beam angle</b>	38°

Visor accessory

75714-2

● Black

<b>Material</b>	<b>Body</b> PC
-----------------	----------------

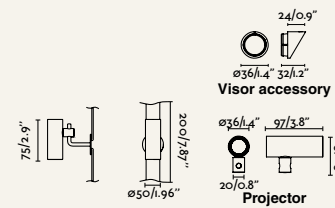

Clap tree mounting projector  
Clap proyector árbol



75703-233DR

● Black

<b>Material</b>	<b>Body</b> Aluminium
<b>Power</b>	6W
<b>Lumen Output</b>	524lm
<b>Light Source</b>	COB LED 3000K
<b>Class</b>	II
<b>CRI</b>	>80
<b>Voltage (V/Hz)</b>	220V-240V/50-60Hz
<b>Beam angle</b>	38°

Visor accessory

75714-2

● Black

<b>Material</b>	<b>Body</b> PC
-----------------	----------------

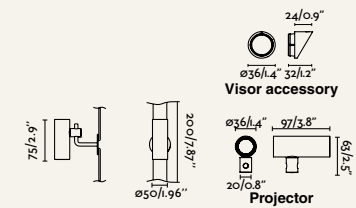





Clap stake 630 24V  
Clap estaca 630 24V

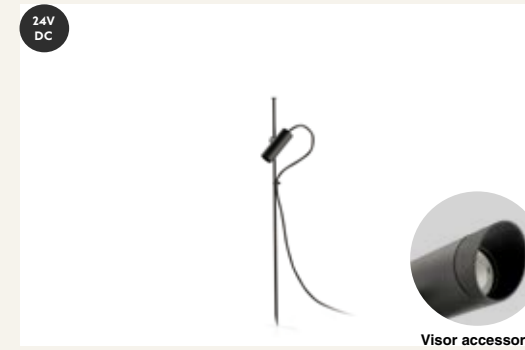

75708-233

● Black

<b>Material</b>	<b>Body</b> Aluminium
<b>Power</b>	6W
<b>Lumen Output</b>	524lm
<b>Light Source</b>	COB LED 3000K
<b>Class</b>	II
<b>CRI</b>	>80
<b>Voltage (V/Hz)</b>	24V DC
<b>Beam angle</b>	38°

Visor accessory

75714-2

● Black

**Material** **Body** PC

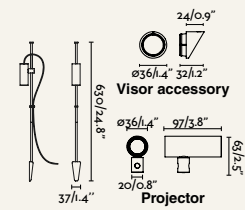

Clap stake 630  
Clap estaca 630

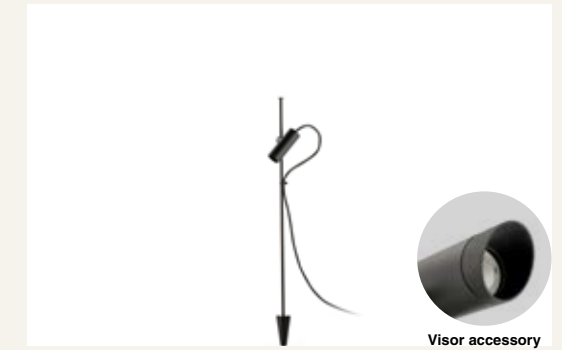

75708-233DR

● Black

<b>Material</b>	<b>Body</b> Aluminium
<b>Power</b>	6W
<b>Lumen Output</b>	524lm
<b>Light Source</b>	COB LED 3000K
<b>Class</b>	II
<b>CRI</b>	>80
<b>Voltage (V/Hz)</b>	220V-240V/50-60Hz
<b>Beam angle</b>	38°

Visor accessory

75714-2

● Black

**Material** **Body** PC

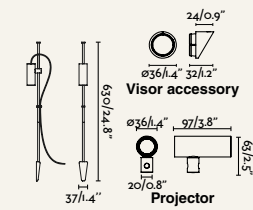





Clap stake 1030 24V  
Clap estaca 1030 24V

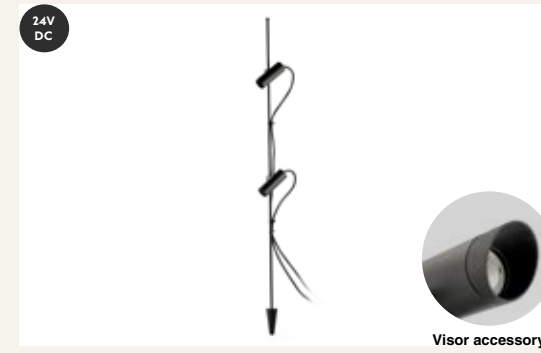

75709-233 ● Black

<b>Material</b>	<b>Body</b> Alumi.+Stainless steel
<b>Power</b>	2X6W
<b>Lumen Output</b>	2x524lm
<b>Light Source</b>	COB LED 3000K
<b>Class</b>	III
<b>CRI</b>	>80
<b>Voltage (V/Hz)</b>	24V DC
<b>Beam angle</b>	38°

<b>Visor accessory</b>	
75714-2	● Black
<b>Material</b>	<b>Body</b> PC

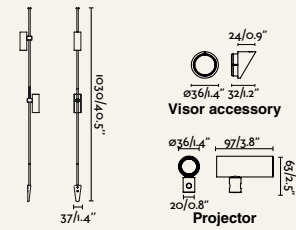

Clap stake 1030  
Clap estaca 1030



75709-233DR ● Black

<b>Material</b>	<b>Body</b> Alumi.+Stainless steel
<b>Power</b>	2X6W
<b>Lumen Output</b>	2x524lm
<b>Light Source</b>	COB LED 3000K
<b>Class</b>	II
<b>CRI</b>	>80
<b>Voltage (V/Hz)</b>	220V-240V/50-60Hz
<b>Beam angle</b>	38°

<b>Visor accessory</b>	
75714-2	● Black
<b>Material</b>	<b>Body</b> PC

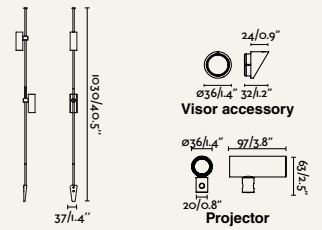



Clap stake 630 w/screen 24V  
Clap estaca 630 c/ pantalla 24V



75708-233P ● Black

Clap stake 630 w/screen  
Clap estaca 630 c/ pantalla



75708-233PDR ● Black

Clap stake 1030 w/screen 24V  
Clap estaca 1030 c/ pantalla 24V



75709-233P ● Black

Clap stake 1030 w/screen  
Clap estaca 1030 c/ pantalla



75709-233PDR ● Black

<b>Material</b>	Body Aluminium
<b>Power</b>	6W
<b>Lumen Output</b>	524lm
<b>Light Source</b>	COB LED 3000K
<b>Class</b>	III
<b>CRI</b>	>80
<b>Voltage (V/Hz)</b>	24V DC
<b>Beam angle</b>	38°

<b>Material</b>	Body Aluminium
<b>Power</b>	6W
<b>Lumen Output</b>	524lm
<b>Light Source</b>	COB LED 3000K
<b>Class</b>	II
<b>CRI</b>	>80
<b>Voltage (V/Hz)</b>	220V-240V/50-60Hz
<b>Beam angle</b>	38°

<b>Material</b>	Body Alumi.+Stainless steel
<b>Power</b>	2X6W
<b>Lumen Output</b>	2x524lm
<b>Light Source</b>	COB LED 3000K
<b>Class</b>	III
<b>CRI</b>	>80
<b>Voltage (V/Hz)</b>	24V DC
<b>Beam angle</b>	38°

<b>Material</b>	Body Alumi.+Stainless steel
<b>Power</b>	2X6W
<b>Lumen Output</b>	2x524lm
<b>Light Source</b>	COB LED 3000K
<b>Class</b>	II
<b>CRI</b>	>80
<b>Voltage (V/Hz)</b>	220V-240V/50-60Hz
<b>Beam angle</b>	38°

<b>Visor accessory</b>	
75714-2	● Black
<b>Material</b>	Body PC

<b>Visor accessory</b>	
75714-2	● Black
<b>Material</b>	Body PC

<b>Visor accessory</b>	
75714-2	● Black
<b>Material</b>	Body PC

<b>Visor accessory</b>	
75714-2	● Black
<b>Material</b>	Body PC

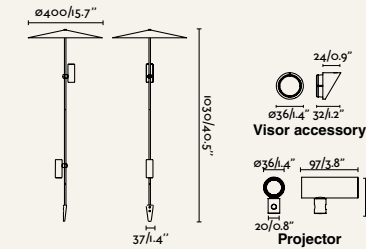
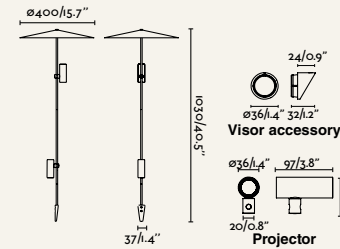
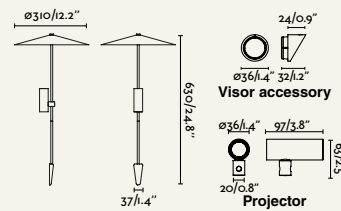
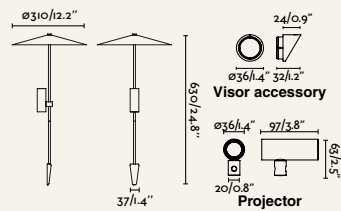



CLAP linear pendant  
*Clap colgante lineal*

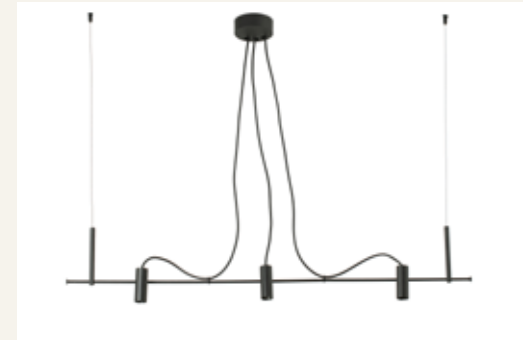

75711-233

● Black

75711-133

● White

<b>Material</b>	<b>Body</b> Aluminium
<b>Power</b>	3X6W
<b>Lumen Output</b>	3x524lm
<b>Light Source</b>	COB LED 3000K
<b>Class</b>	I
<b>CRI</b>	>80
<b>Voltage (V/Hz)</b>	220V-240V/50-60Hz
<b>Beam angle</b>	38°

**Visor accessory**

75714-2

● Black

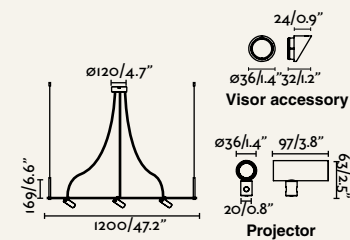
**Material****Body** PC

# SUSPENDED



## Logistic Headquarters

---

Calle Dinámica 1  
Polígono Industrial Santa Rita  
08755 Castellbisbal (Barcelona)  
Tel +34 93 772 39 49  
info@faro.es

## Showrooms

---

BARCELONA  
Princesa  
Calle Princesa, 52  
08003, Barcelona  
Tel +34 93 238 73 73  
showroom.barcelona@faro.es

MADRID  
docontract MAD  
Calle Velázquez, 35, 4ºD  
28001, Madrid  
Tel +34 689 583 571  
showroom.madrid@faro.es

PARIS  
7 Rue d'Uzès,  
75002 Paris  
Tel +34 687 845 758  
showroom.paris@faro.es